

2C

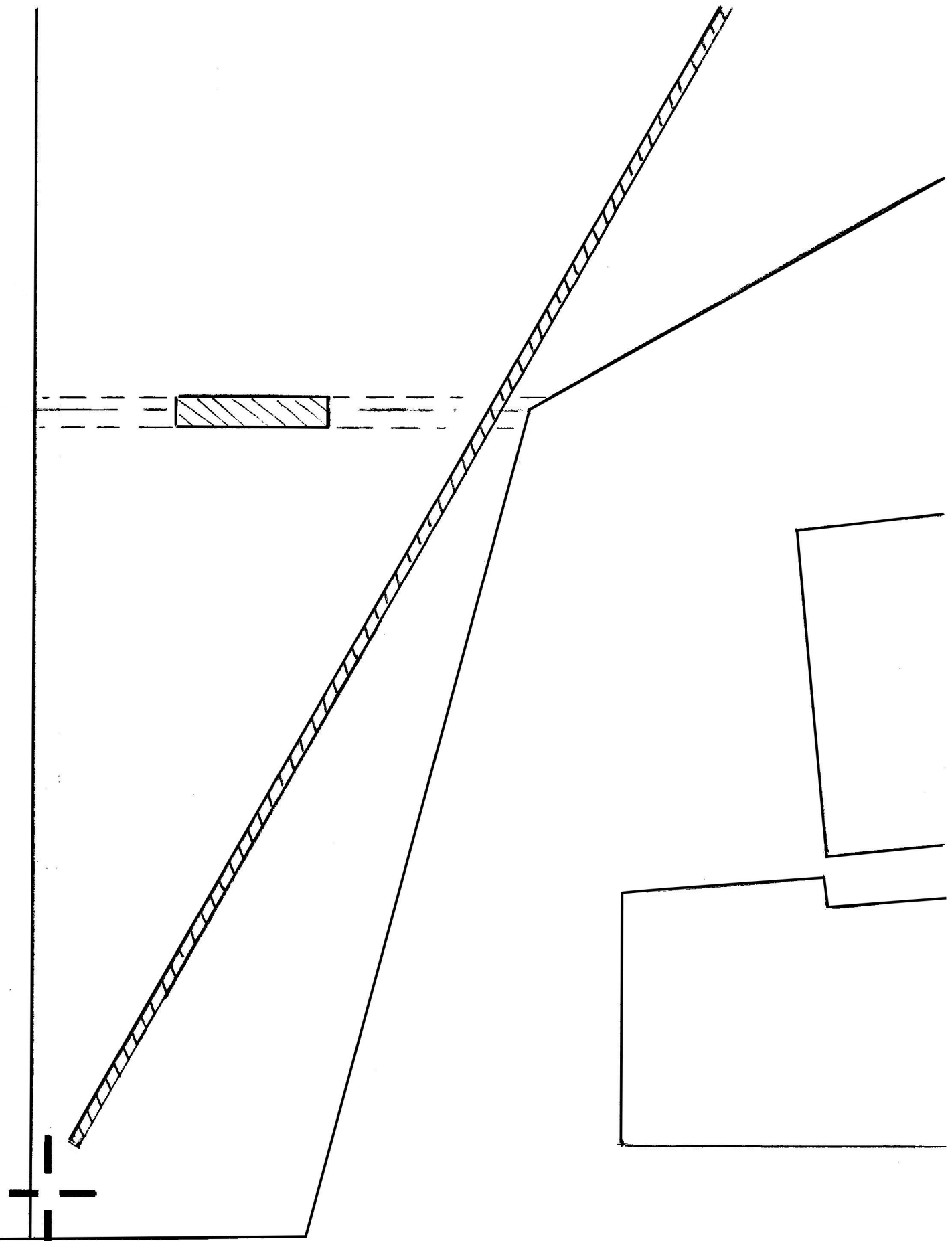

**3A**

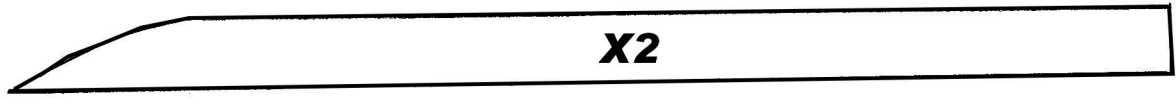
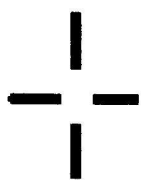

**X2**

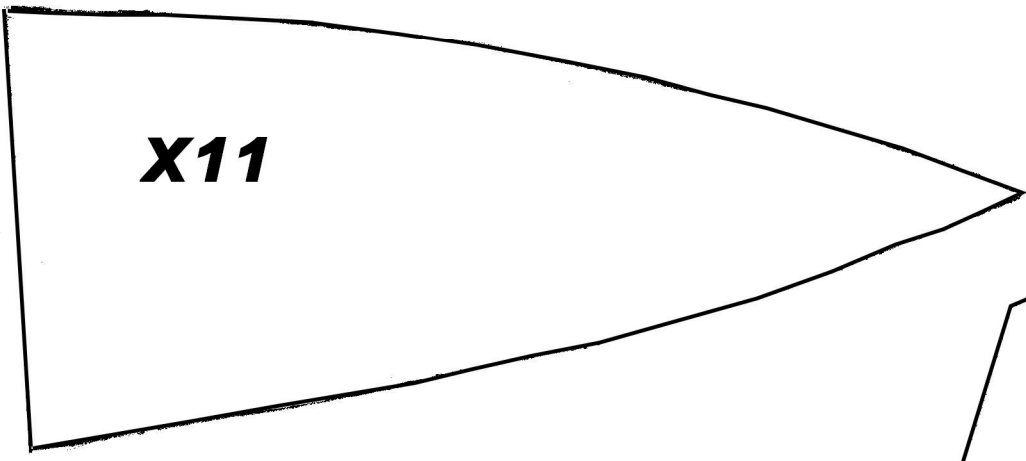

**X11**

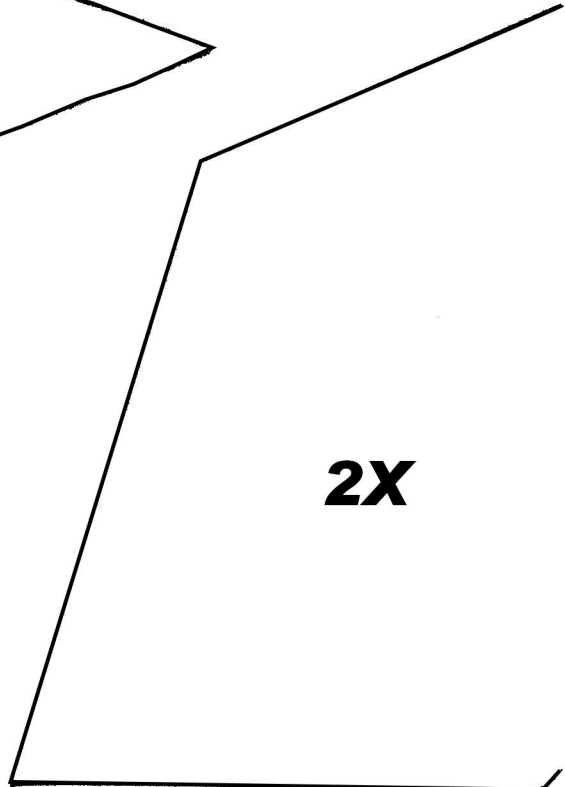

**2X**

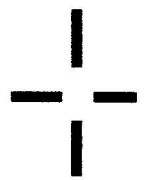
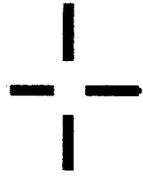

3B

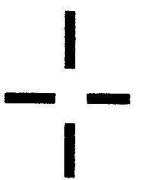
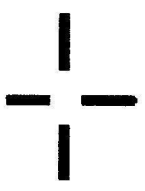
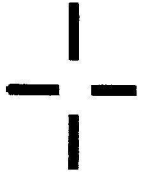
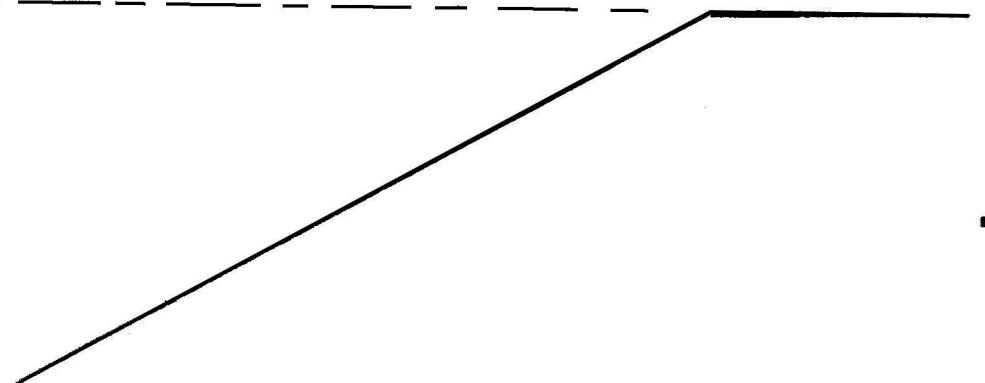
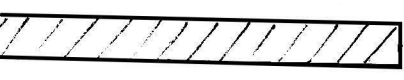
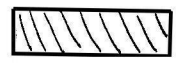
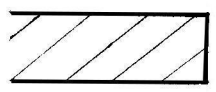
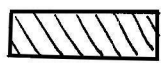
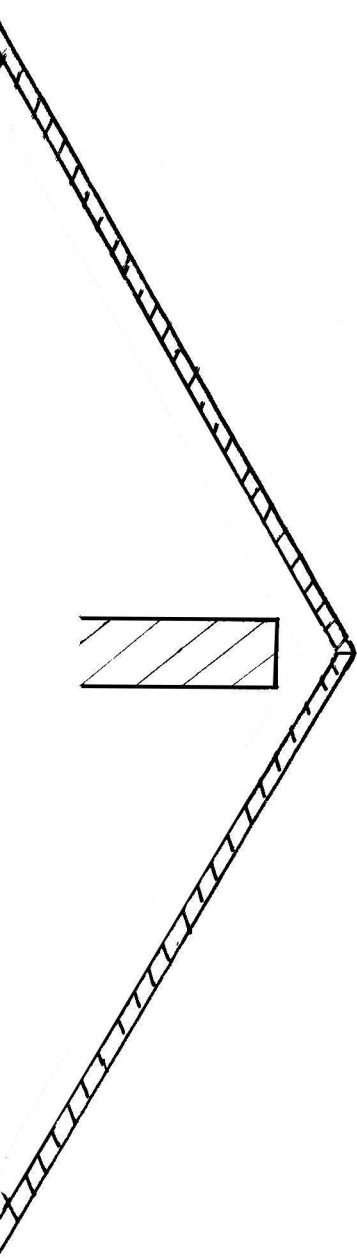
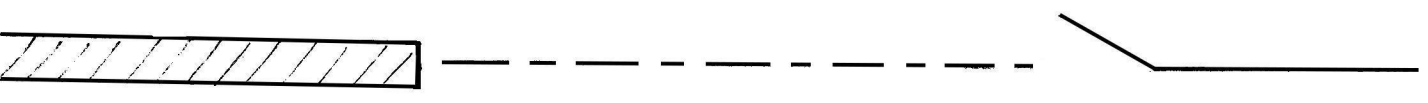

3C

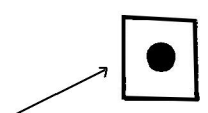
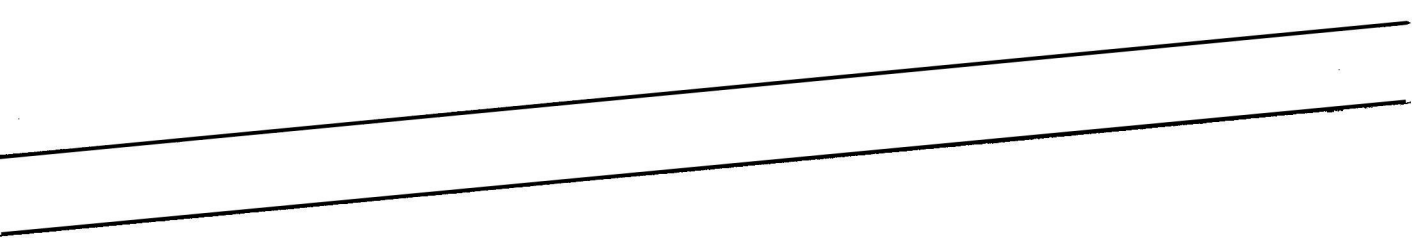
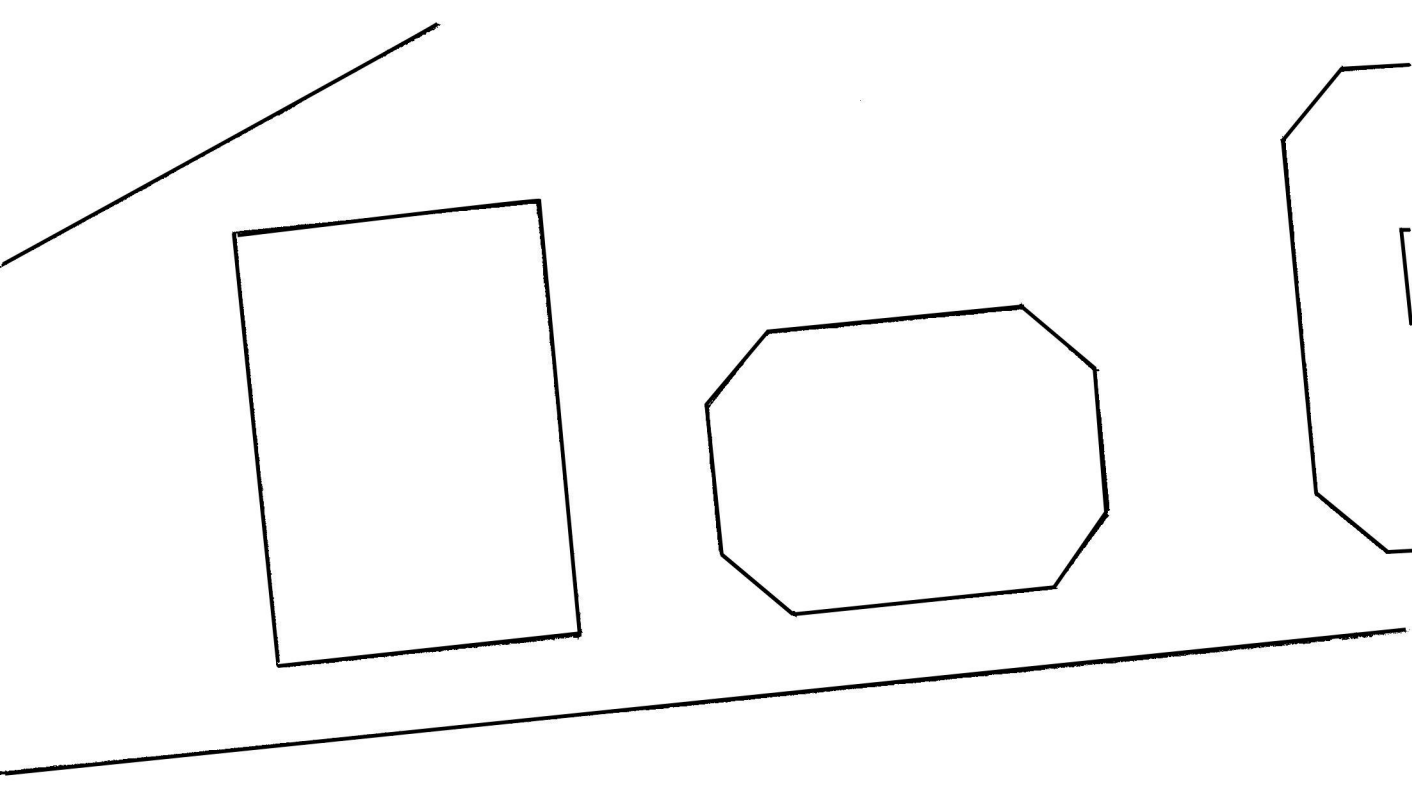
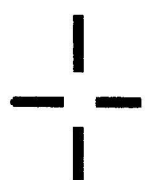

support en C.P pour  
passage tube carbone  
diam 4mm

2X

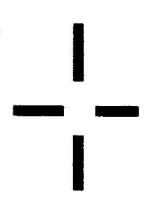
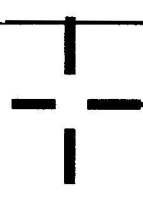

4A

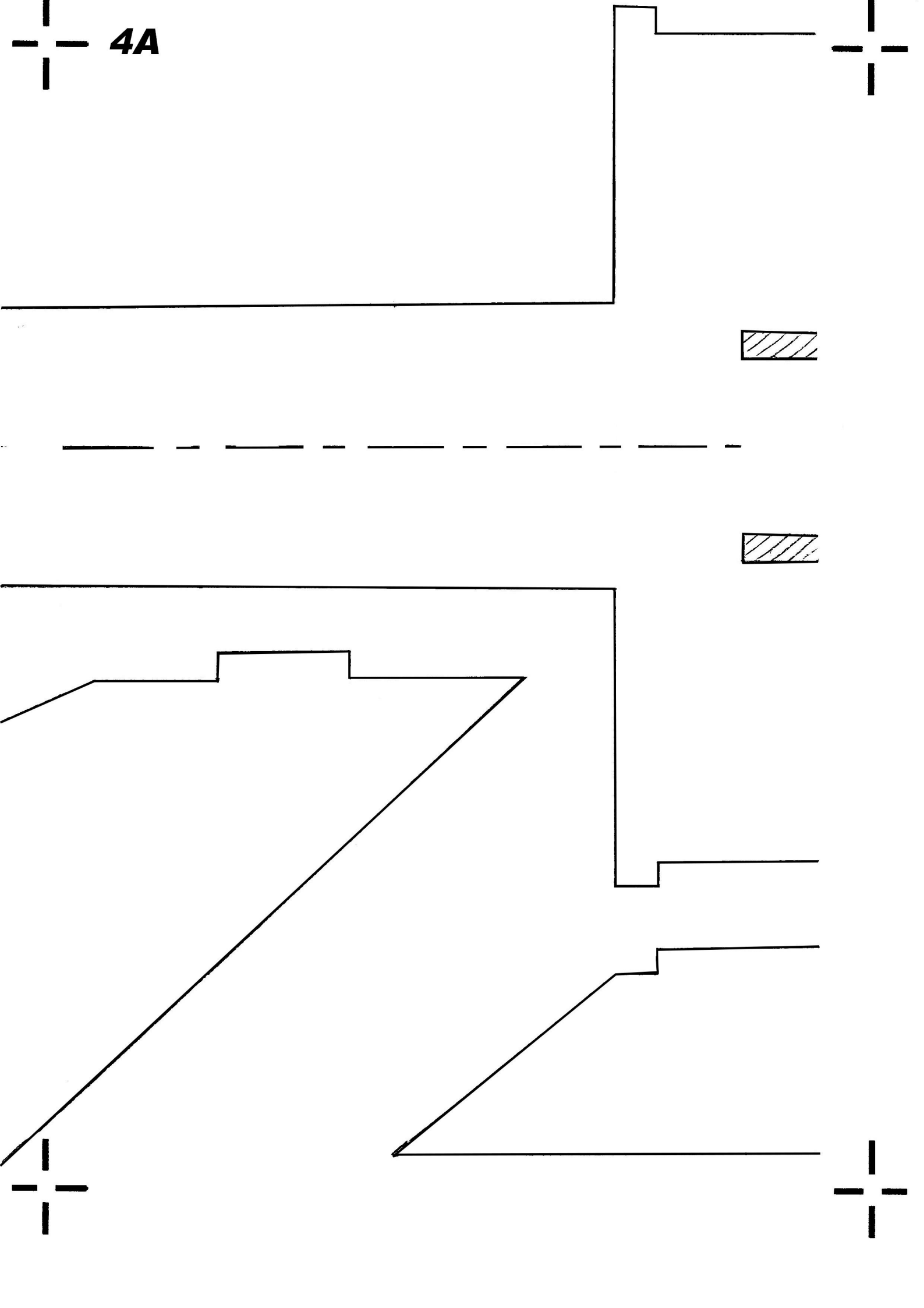

4B

SERVO DE  
PROFONDEUR

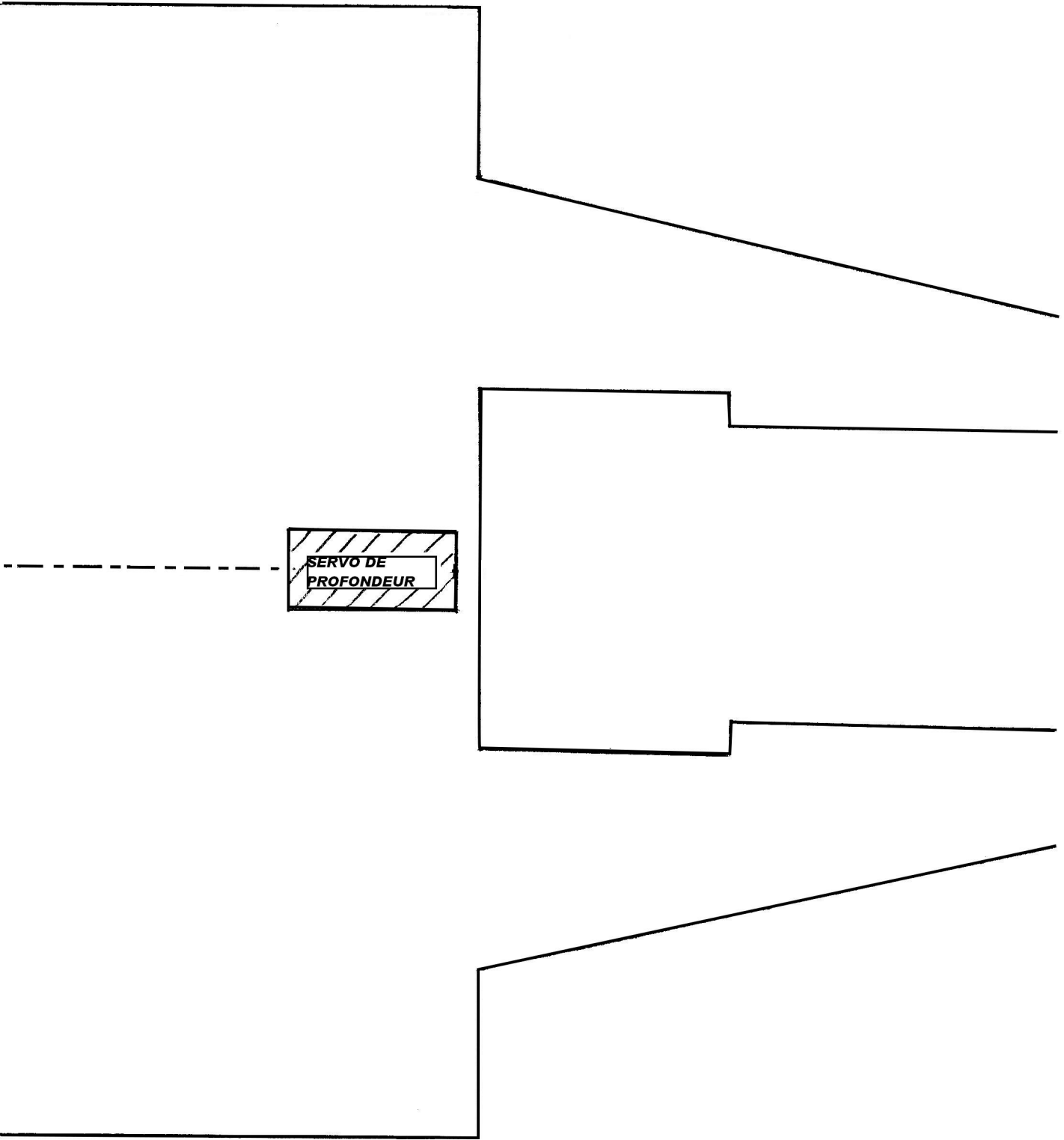

4C

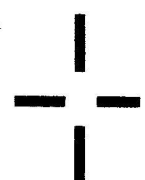
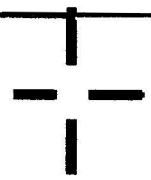
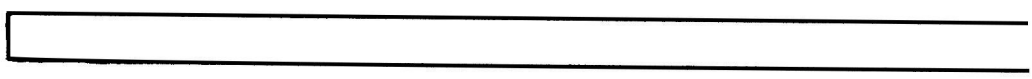
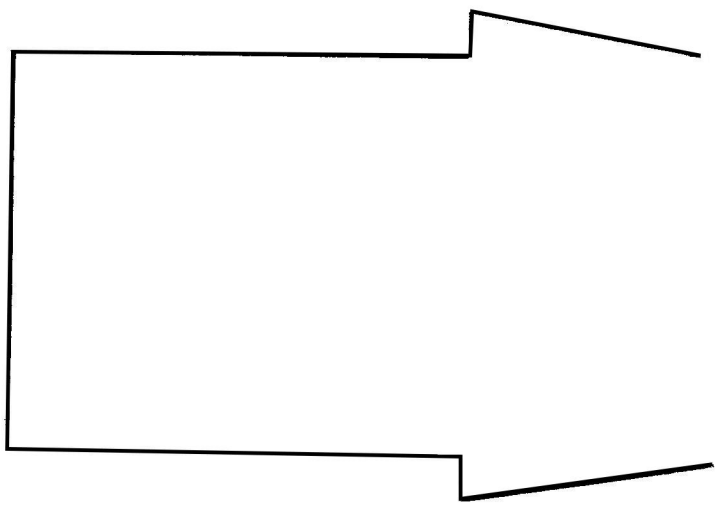
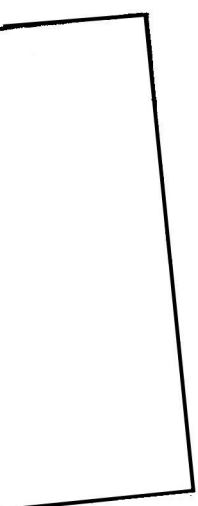
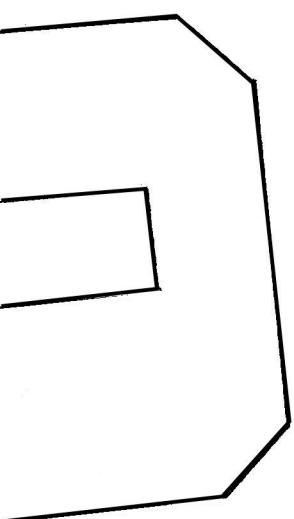
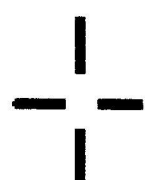

**5A**

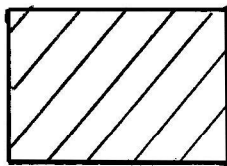
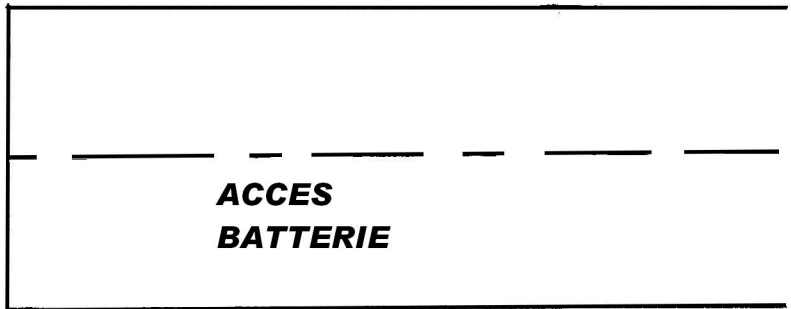
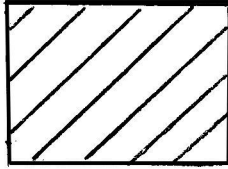

**PRISES POUR  
LANCER A LA  
MAIN**

**X2**



5B

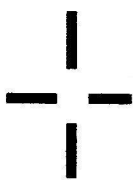
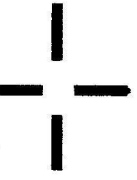
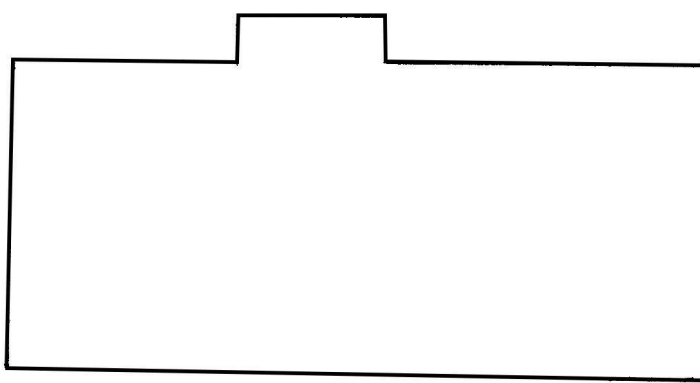
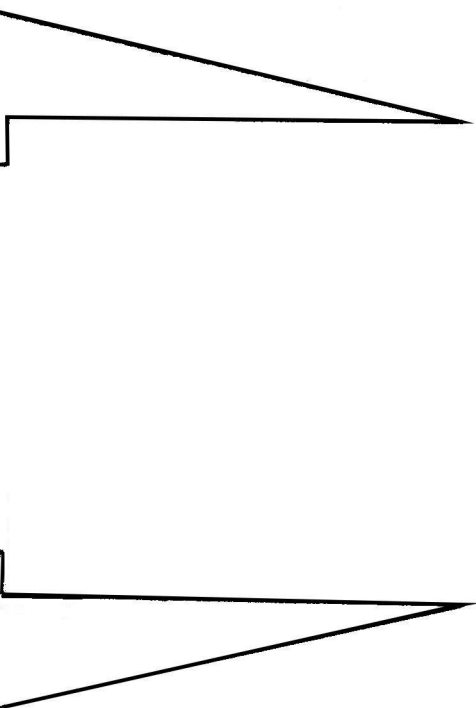
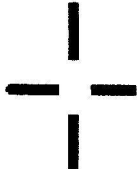

5C

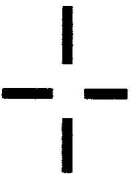
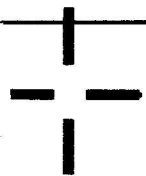
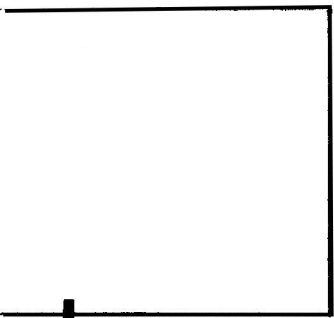
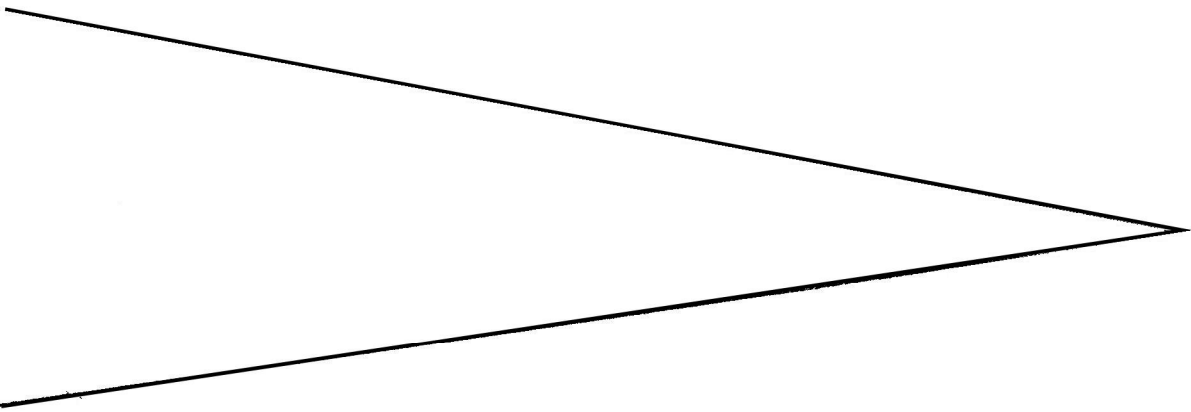
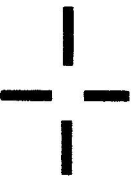

**6A**

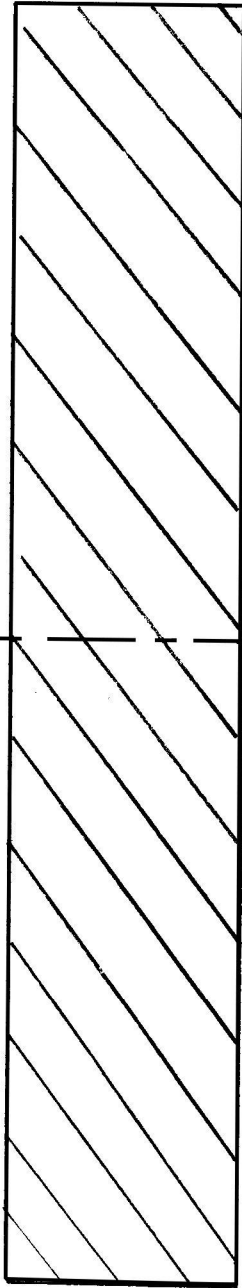

**SERVOS**

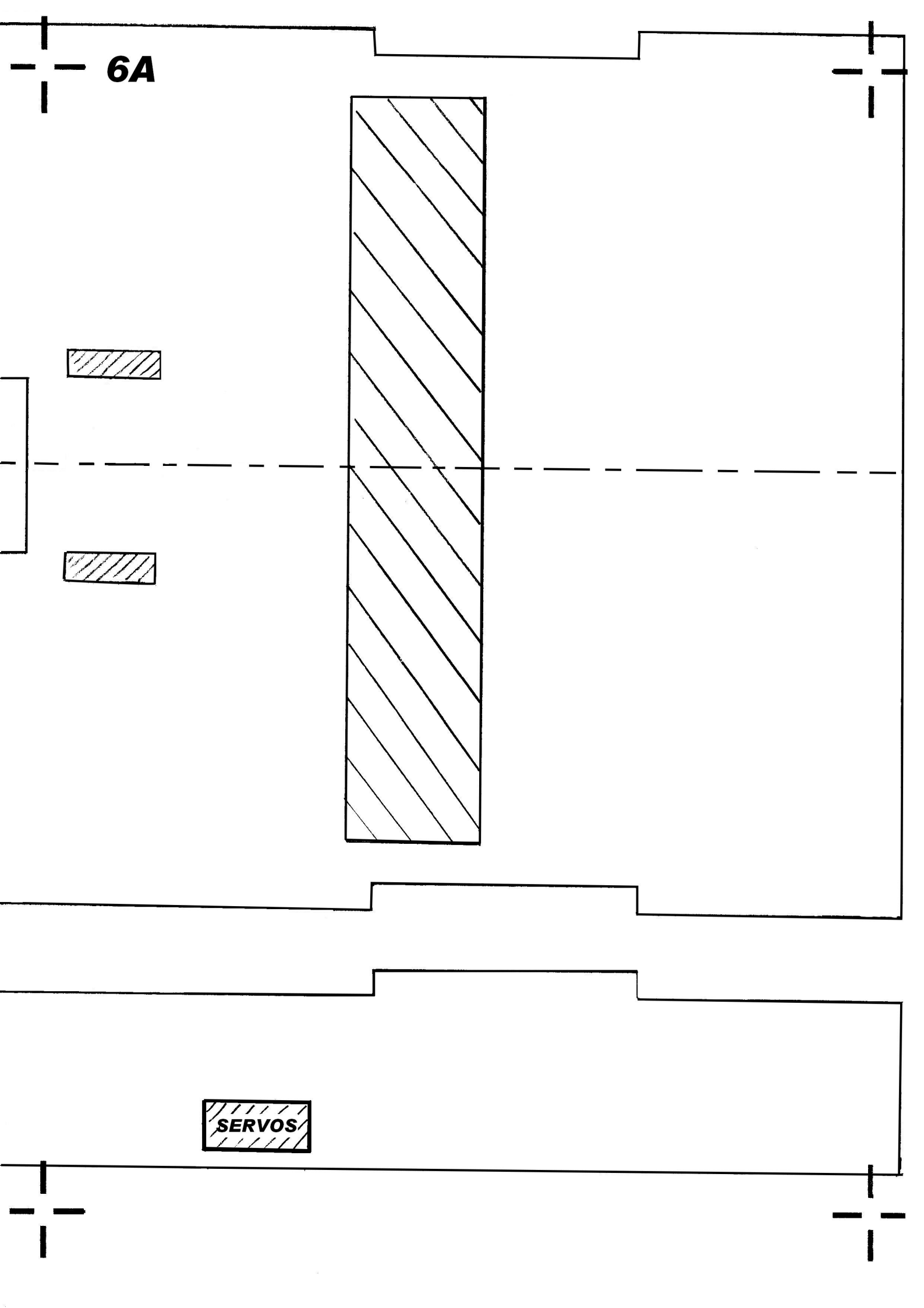

6B

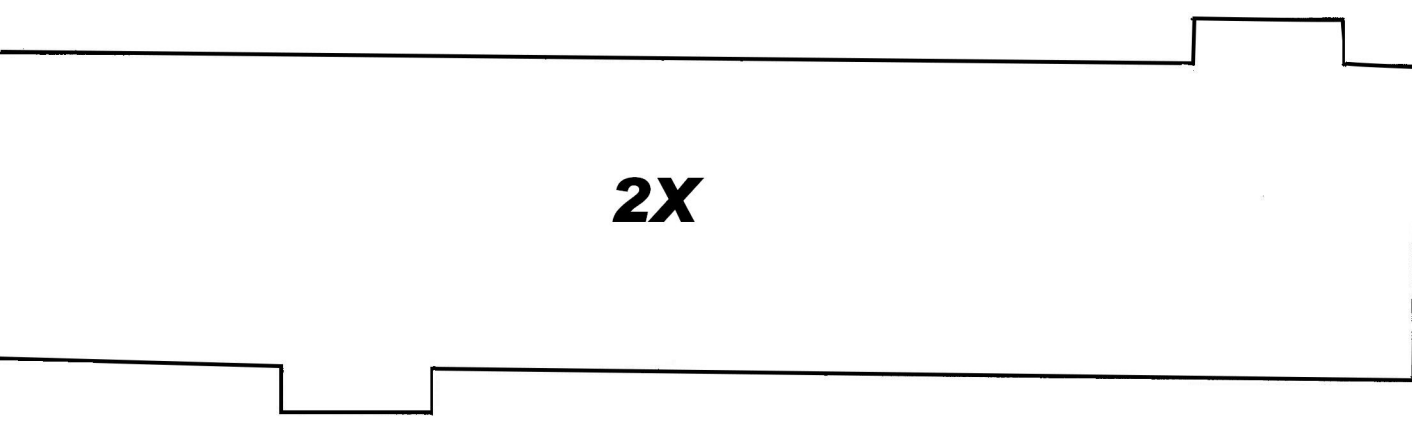
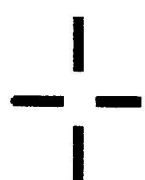

2X

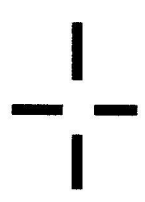
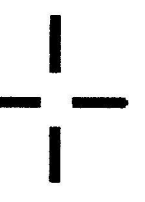

6B

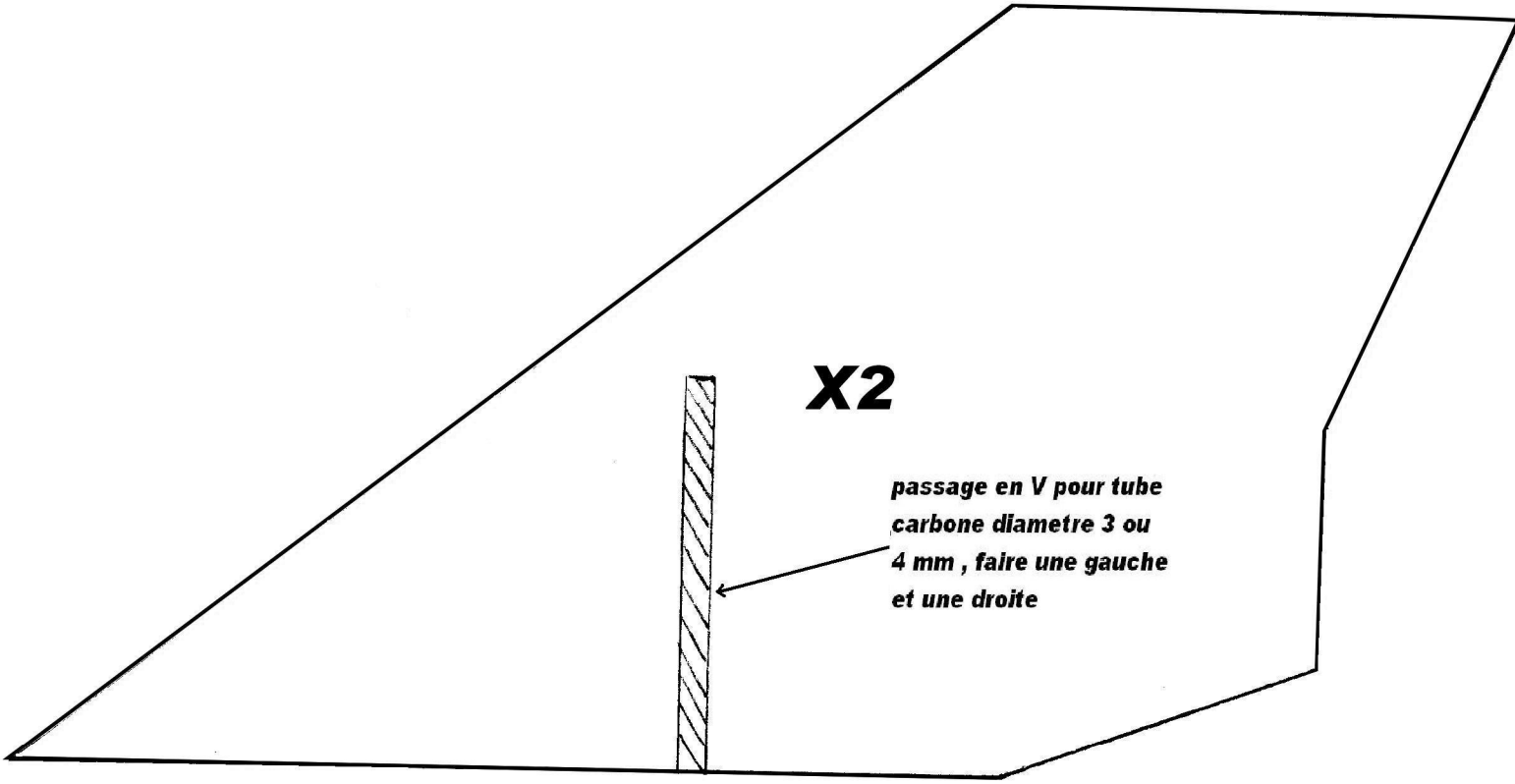

**TOUTES LES  
PIECES SONT  
EN DEPRON  
OU  
EXTRUPOR DE  
6mm**

LONG: 970mm (36.22")  
ENV: 765mm (30.12")  
POIDS: en ordre de vol  
450gr (15.87 Oz)

# VANTIS PARK JET

DESIGNE BY DAVID MARTEL © 2009 ALL RIGHTS RESERVED

**Vous pouvez télécharger, imprimer, utiliser et partager ces plans comme vous le souhaitez, cependant, si vous les aimez envisagez s'il vous plaît d'envoyer une petite contribution au designer pour montrer votre appréciation pour tout le travail et le développement . La contribution suggérée est 10 \$ et peut être envoyée via PayPal à [BLINXS@ORANGE.FR](mailto:BLINXS@ORANGE.FR) Merci de votre appui!**

## [WWW.POIDS-PLUME-RC.COM](http://WWW.POIDS-PLUME-RC.COM)

**You may download, print, use, and share these plans as you like, however, if you enjoy them please consider sending a small contribution to the designer to show your appreciation for all the work that went into developing them. The suggested contribution is \$10, and can be sent via PayPal to [BLINXS@ORANGE.FR](mailto:BLINXS@ORANGE.FR) Thanks for your support!**

**1A**

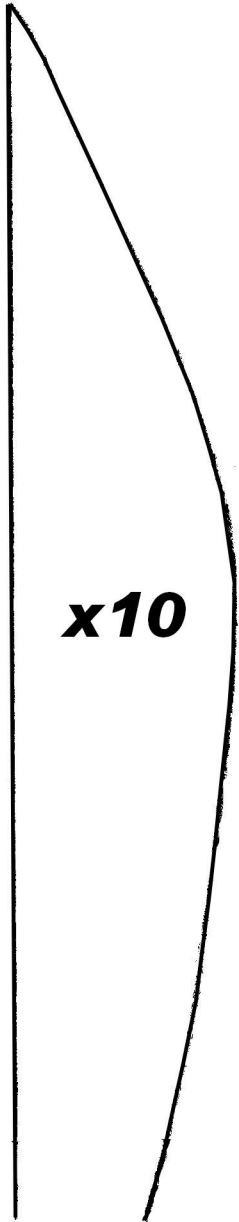

**1B**

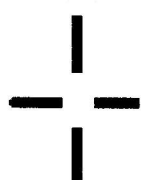
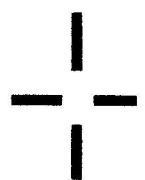
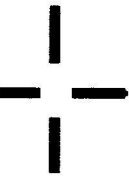
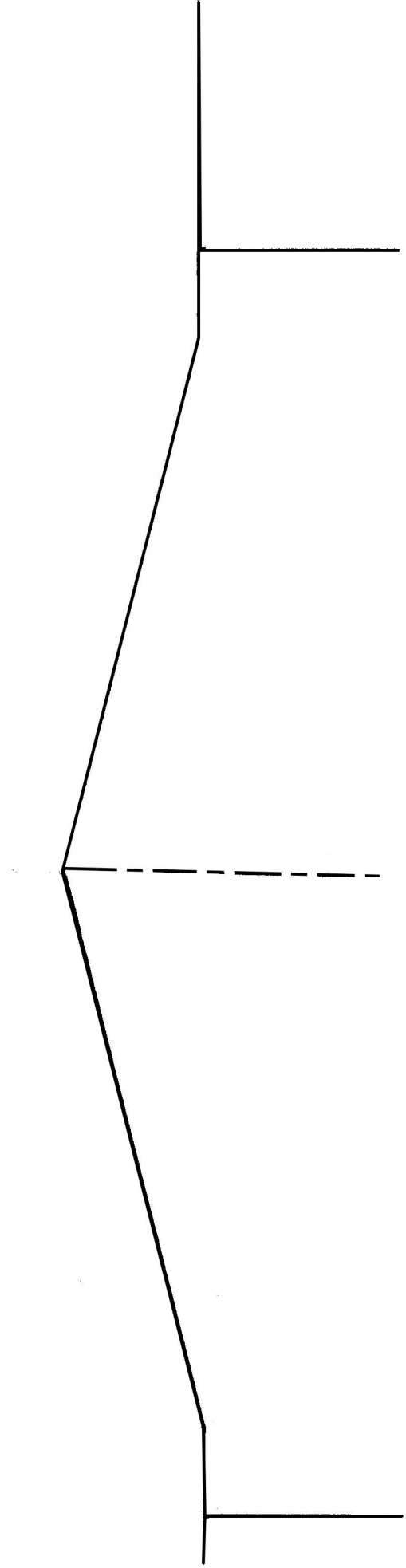
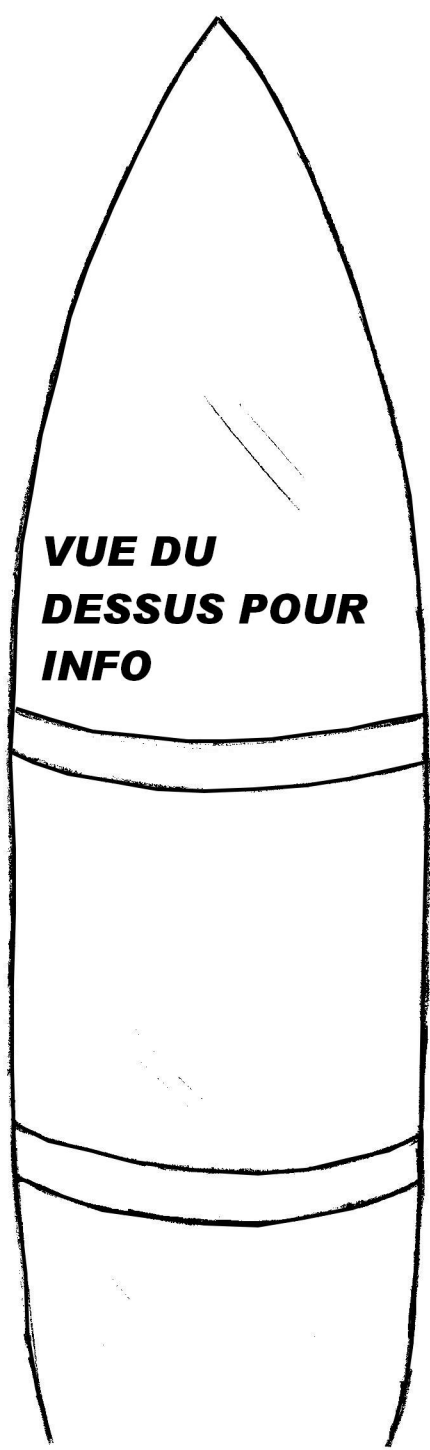

1C

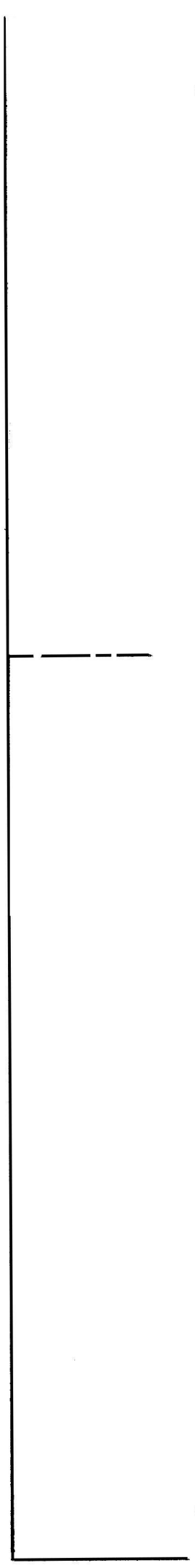
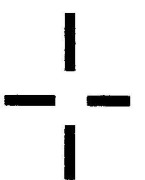
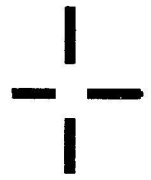
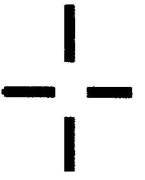
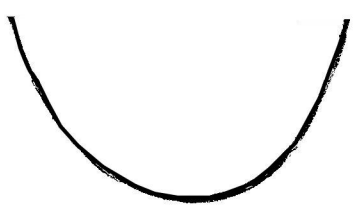



**2A**

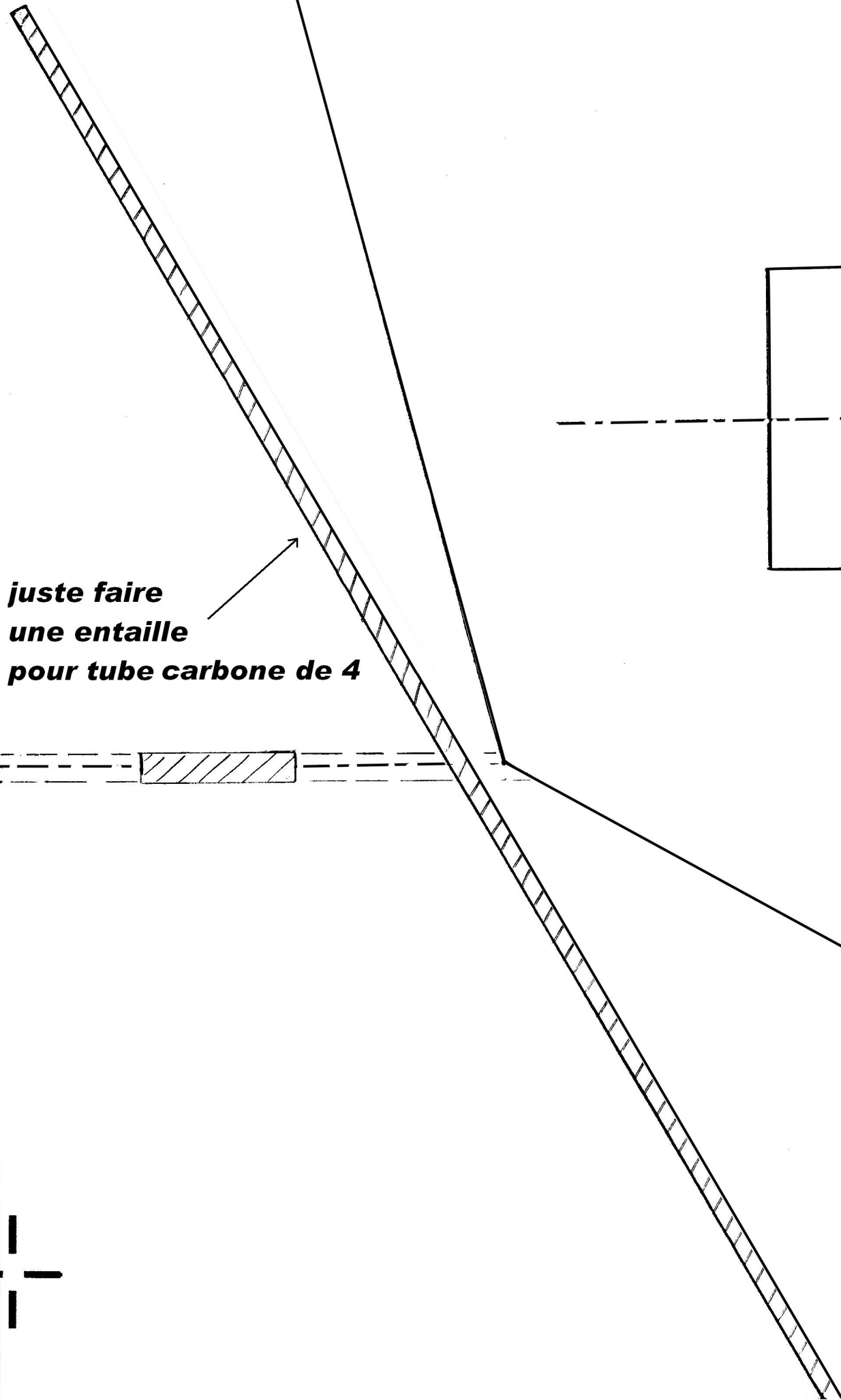

**juste faire  
une entaille  
pour tube carbone de 4**

**2B**

